

TECHNICAL SPECIFICATIONS

Cooking block dimensions	690mm x 690mm x 70.5mm To be integrated into the worktop
Cooking surface	690mm x 690mm Glass ceramic thickness 6mm
Power	32000W (16 inductors of 2000W)
Controls	Touch-sensitive keyboard with joystick and displays
Amperage	48A
Functions L'Original	<p>The No Limit innovation is based on the principle: 1 inductor = 1 zone.</p> <p>16 coils / 16 cooking zones, controlled by 2 touch-sensitive keypads with 4 joysticks and 16 displays 4-digit.</p> <p>Adjustable power and temperature: - Power adjustment - 30 levels from 25 to 2000W per inductor - Temperature setting from 30°C to 250°C in 1°C steps</p> <p>Integrated programme function with 3 memory settings</p>
Power supply	380V Three-phase 50-60Hz Compatible with TERA WATT and SI-COTRONIC energy optimisers.
Diameter saucepan	Minimum 6 cm
Standards	Complies with current European standards on the safety of electrical equipment, EMC, Rohs and SGS
Kit composition	- 1 Cooktop - 4 Generator blocks - 2 Knobs control - 1 Integration frame (750 x 750mm) - Connecting cables 1m50 (Custom connection cables available in 3, 5, 6, 8, 10, 12, 15m)

L'Original

Features KNL16 Front to Back

The No Limit KNL16 hob has 16 cooking zones with adjustable power or temperature. Each cooking zone can be controlled independently :

- 16 Cooking zones
- 16 Inductors
- 2 Controls for the 16 cooking zones

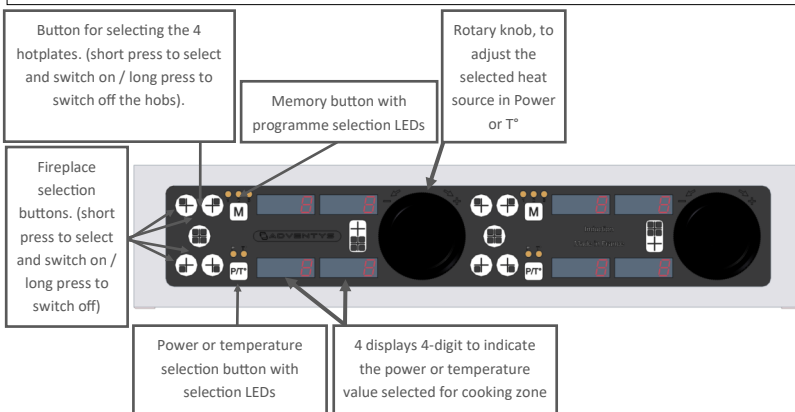
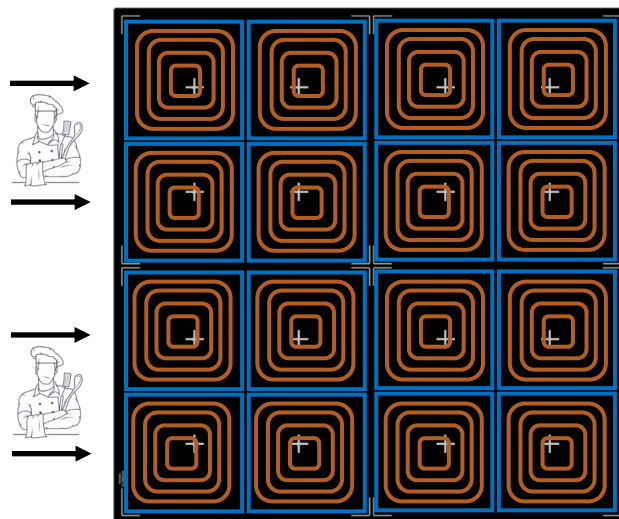

ADVENTYS
 Route de Pagny - 21250 Seurre - France
www.adventys.com
contact@adventys.com
 T: 03.80.20.46.15

Importante Note
 Adventys reserves the right to change specifications without notice.

Cooking block dimensions

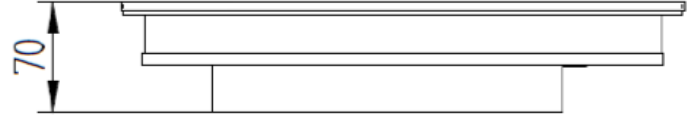
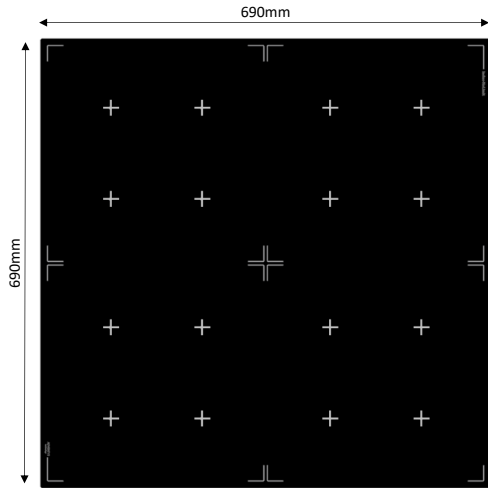

Integrated cooking unit dimensions : 696mm x 696mm

Dimensions Control panel (420x 120)

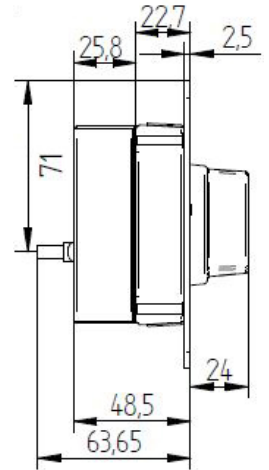
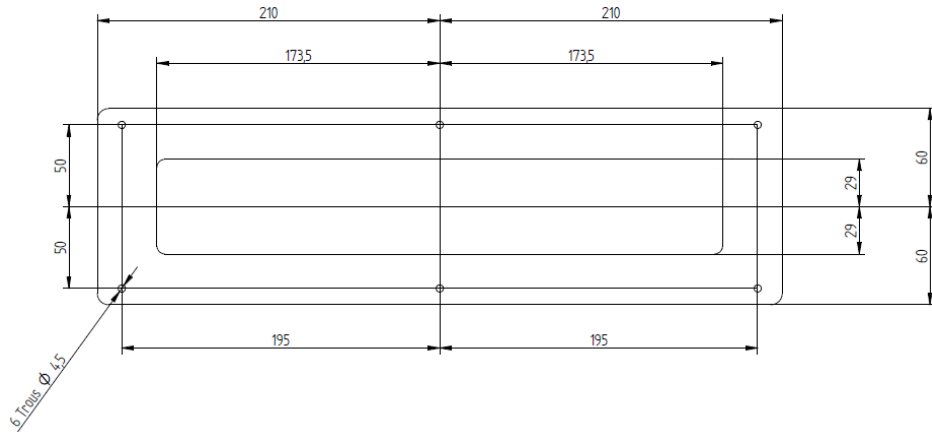

Built-in dimensions control 390 x 88 mm + 6 holes R4,5mm

Generator dimensions

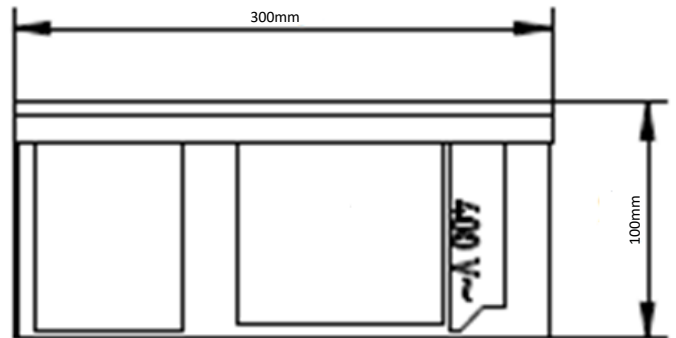
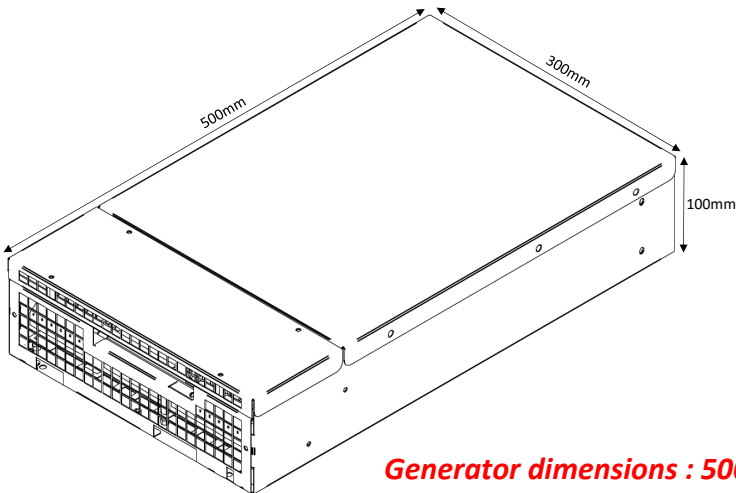

Generator dimensions : 500mm x 300mm x 100mm

ADVENTYS
 Route de Pagny - 21250 Seurre - France
www.adventys.com
contact@adventys.com
 T: 03.80.20.46.15

Importante Note
 Adventys reserves the right to change specifications without notice.