

# 1 Door Roma Rotating Oven

RIF. COD. FRIB

FEATURES	UM	Ø 125
Height of the cooktop	cm	120
Door width	cm	54/68 / 82
Power consumption	Kw	0,36
Total weight (standard finish)	Kg	1600
Capacity	nr.	8-9
Supply		Legna-Gas
Under-floor burner		o
Minimum flue dimensions: Ø 20 cm		

## AVAILABLE SHAPES



DIMENSIONS	UM	Ø 125
A - Depth	cm	200
B - Width	cm	195
C - Height	cm	200
D	cm	120
E	cm	138
F	cm	116
G	cm	149
External band projection over the feet of the oven cm 10		

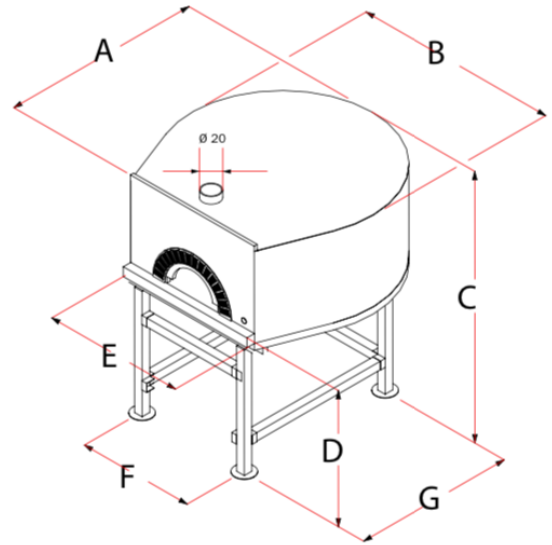

GAS DATA	UM	Ø 125
Thermal power	kW	34
LPG consumption	kg/h	2,681
Methane Consumption	m³/h	3,598
Flue gas temperature	°c	200
Draft	pascal	12 pa
Gas connection	inches	1/2
Type of construction		A1-BIIBS
energy Consumption	W	370

## CAPACITY

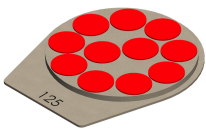

Ø 125